

NOVITÀ 2021



hatria

NOVITÀ 2021

BAHIA_13	2
PETRA_H3 Ardesia	18
BIANCA	30
VASCHE FREESTANDING E SPECCHI	36
SCHEDE TECNICHE	42



BAHIA_13

UN NUOVO MONDO DI SOLUZIONI INTEGRATE PER IL TUO BAGNO
A NEW WORLD OF INTEGRATED SOLUTIONS FOR YOUR BATHROOM



FUSION



FUSION 355x540



FUSION COMPACT 355x485



BIANCA

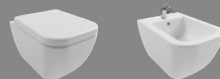

360x520



BEAT

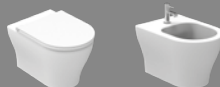

360x520



VASCA OVALE BT_01



1700x780x600



VASCA RETTANGOLARE BT_02



1700x740x590



BAHIA_13



1000x465



800x465 dx-rh



800x465



800x365



600x465



600x365



500x465



500x365



450x250



500x380



01 BIANCO
WHITE



25 BIANCO MATT
WHITE MATT



L'ELEGANZA UNICA E I DETTAGLI ESCLUSIVI DEI LAVABI CERAMICI

The unique elegance and exclusive details of the ceramic washbasins
 Die einzigartige Eleganz und die exklusiven Details der Keramikwaschbecken
 L'élégance unique et les détails exclusifs des lavabos en céramique
 La elegancia única y los detalles exclusivos de los lavabos de cerámica
 Уникальная элегантность и эксклюзивность керамических раковин

L'ineguagliabile design ed eleganza Made in Italy della collezione di lavabi in ceramica, disponibili con finitura lucida o matt, è caratterizzata dai bordi lineari, armonici nelle proporzioni, moderni e sottili, di soli 6 mm di spessore, che garantiscono un'estetica elegante. La gamma è sviluppata fino ai 100 cm di larghezza, e sue due profondità (di 46.5 e 36.5 cm) per adattarsi al meglio a tutti gli ambienti bagno. Inoltre sono unici nel loro genere perché sono disponibili sia con foro troppopieno che senza. L'assenza del foro troppopieno, eliminando interruzioni estetiche conferisce al lavabo un aspetto ancora più armonioso. Lo speciale smalto antibatterico Hatria garantisce ai lavabi la massima igienicità.

The unique elegance and exclusive details of the ceramic washbasins
 The unrivalled Made in Italy design and elegance of the ceramic washbasin, available with glossy or matt finish, is characterized by linear edges, harmonious in proportions, modern and thin, only 6 mm thick, which guarantee an elegant aesthetic. The range is developed up to 100cm in width, and its two depths (of 46.5 and 36.5 cm) are to best adapt to all bathrooms. The washbasins are unique because they are available both with and without overflow hole. The absence of the overflow hole, eliminating aesthetic interruptions, gives the washbasin an even more harmonious appearance. The special Hatria antibacterial glaze guarantees the washbasins maximum hygiene.

Das unvergleichliche Design und die Eleganz der „Made in Italy“ Keramikwaschbecken-Kollektion, die in glänzendem oder mattem Oberflächen erhältlich sind, zeichnen sich durch lineare Kanten aus, die in ihren Maßen harmonisch, modern, dünn, nur 6 mm dick und eine elegante Ästhetik garantieren. Das Sortiment ist bis zu einer Breite von 100 cm und in zwei Tiefen (46,5 und 36,5 cm) erhältlich, um sich an alle Badezimmer anzupassen. Sie sind auch in ihrer Art einzigartig, da sie sowohl mit als auch ohne Überlaufloch verfügbar sind. Das Waschbecken ohne Überlaufloch verleiht ein noch harmonischeres Aussehen. Die spezielle antibakterielle Hatria-Glasur garantiert den Waschbecken maximale Hygiene.

Le design et l'élégance inégalés Made in Italy de la collection de lavabos en céramique, disponibles avec une finition brillante ou mate, se caractérisent par des bords linéaires, harmonieux dans les proportions, modernes et ultra fins, seulement 6 mm d'épaisseur, qui garantissent une esthétique élégante. La gamme est développée jusqu'à 100cm de largeur, et de deux profondeurs (46,5 et 36,5 cm) pour s'adapter au mieux à tous les environnements de salle de bain. Ils sont également uniques en leur genre car ils sont disponibles avec ou sans trou de trop-plein. L'absence de trou de trop-plein, éliminant les interruptions esthétiques, donne au lavabo un aspect encore plus harmonieux. L'émail antibactérien spécial Hatria garantit une hygiène maximale des lavabos.

El inigualable diseño "Made in Italy" y la elegancia del lavabo de cerámica, disponible en acabado brillante o mate, caracterizado por cantos lineales, armoniosos en proporciones, moderno y fino, de tan solo 6 mm de espesor, que garantizan una estética elegante. La gama se desarrolla hasta los 100cm de ancho, y sus dos profundidades (de 46,5 y 36,5 cm) son para adaptarse mejor a todos los baños. Los lavabos son únicos porque están disponibles con y sin rebosadero. La ausencia del rebosadero, eliminando las interrupciones estéticas, confiere al lavabo un aspecto aún más armonioso. El esmalte especial antibacteriano Hatria garantiza la máxima higiene de los lavabos.

Непревзойденный дизайн и элегантность коллекции керамических умывальников «Made in Italy», доступные в глянцевой или матовой отделке, характеризуются прямыми линиями, гармоничные пропорции, современный дизайн с тонкими бортами, толщиной всего 6 мм, которые гарантируют элегантный эстетический вид. Диапазон ширины составляет до 100 см и две глубины (46,5 и 36,5 см), чтобы наилучшим образом адаптироваться к любому варианту ванной комнаты. Они также уникальны в своем роде, потому что доступны как с переливным отверстием, так и без него. Отсутствие переливного отверстия, убирает эстетические недостатки и придает раковине еще более гармоничный вид. Специальная антибактериальная эмаль Hatria гарантирует максимальную гигиену умывальника.

BAHIA_13 UN SISTEMA MODULARE DAL DESIGN MINIMALE E POLIEDRICO

A modular system with a minimal and faceted design
 Ein modulares System mit minimalem und vielseitigem Design
 Un système modulaire au design minimaliste et multiforme
 Un sistema modular con un diseño minimalista y elegante
 Модульная система в стиле минимализм и многогранности

Una ricca gamma di soluzioni tra cui scegliere per colori, finiture e dimensioni, che integra 10 lavabi con mobili coordinati e accessori che rendono possibile la progettazione e l'arredamento della stanza da bagno a misura di ogni esigenza.

A wide range of solutions to choose from colors, finishes and sizes, which integrates 10 washbasins with coordinated furniture and accessories that make it possible to design and furnish the bathroom to suit every need.

Eine reiche Wahl von Lösungen in Bezug auf Farbe, Endbearbeitung und Größen, für 10 verschiedene Waschbecken mit passenden Möbeln und Zubehör ergänzen, die es ermöglichen, das Badezimmer für jeden Bedarf zu entwerfen und einzurichten.

Une large gamme de choix pour les couleurs, les finitions et les dimensions, qui intègre 10 lavabos avec des meubles et accessoires coordonnés qui permettent de concevoir et de meubler la salle de bain pour répondre à tous les besoins.

Una amplia gama de soluciones para elegir entre colores, acabados y medidas, que integra 10 lavabos con muebles y accesorios a juego que permiten diseñar y amueblar el baño a la medida de cada necesidad.

Широкий ассортимент решений, где можно выбрать цвет, отделку, размер, которое включает 10 умывальников с мебелью и аксессуарами, которые позволяют спроектировать любую композицию под необходимые размеры.

L'offerta Bahia_13 è ulteriormente arricchita da strutture contenitive a cassetti, con 2 profondità e modulari, nelle dimensioni dei lavabi e disponibili in 5 colori naturali. I due cassetti del mobile hanno le sponde in metallo verniciato con guide ad estrazione totale e chiusura ammortizzata per garantire un maggior confort nell'utilizzo. Il fondo interno dei cassetti è rivestito con un materiale effetto pelle, in tinta con la struttura interna, che conferisce pregio e praticità al mobile. In aggiunta, una serie di strutture in metallo con comodi ripiani portaoggetti, disponibili sia a terra e che sospese, le barre portasciugamani, sia frontali che laterali, i sifoni dal design raffinato, regolabili in altezza, disponibili nei colori nero matt e cromo lucido e le pilette in ceramica, offrono soluzioni originali e funzionali per arredare ogni ambiente bagno.

Bahia_13 offer is further enriched by cabinets with drawers, with 2 depths and modular, with the sizes of the washbasins and available in 5 natural colors. The two drawers of the cabinet have sides in painted metal, fully extractable guides and soft closing to ensure greater comfort in use. The internal bottom of the drawers is covered with a leather-effect material, matching the internal structure, which gives value and practicality to the cabinet. In addition, a series of metal structures with comfortable storage shelves, available both floor mounted and wall hung, the towel racks, both front and side, the siphons with a refined design, adjustable in height, available in matt black and glossy chrome and the ceramic drains, offer original and functional solutions to furnish any bathroom.

Das Bahia_13-Angebot wird durch Schubladen mit 2 Tiefen und Baukastensystem in der Größe der Waschbecken und in 5 natürlichen Farben ergänzt. Die beiden Schubladen des Schrankes haben die Seiten aus lackiertem Metall mit vollständig herausziehbaren Führungen mit weichem Schließen, um eine Benutzerfreundlichkeit zu gewährleisten. Der Innenboden der Schubladen ist mit einem Material in Lederoptik in der gleichen Farbe wie die Innenstruktur des Schrankes bedeckt, um Wert und Zweckmäßigkeit zu gewährleisten. Darüber hinaus eine Reihe von Metallkonstruktionen mit bequemen Regalbrettern, die sowohl für den Boden als auch wandhängend erhältlich sind. Diese haben Handtuchhalter sowohl vorne als auch an der Seite und die Siphons mit einem raffinierten Design, höhenverstellbar, in mattem Schwarz und glänzendem Chrom verfügbar sind. Die Keramikabläufe bieten originelle und funktionale Lösungen für jedes Badezimmer.

L'offre Bahia_13 est encore enrichie par des structures de rangement avec tiroirs, à 2 profondeurs et modulables, selon la taille des lavabos et disponibles en 5 coloris naturels. Les deux tiroirs du meuble ont des côtés en métal peint avec des glissières entièrement extractibles et une fermeture douce pour assurer un plus grand confort d'utilisation. Le fond intérieur des tiroirs est recouvert d'un matériau effet cuir, de la même couleur que la structure interne, ce qui donne de la valeur et de la praticité au meuble. En outre, une série de structures métalliques avec des étagères de rangement confortables, disponibles à la fois au sol et suspendues, les porte-serviettes, à l'avant et sur les côtés, les siphons au design raffiné, réglables en hauteur, disponibles en noir mat et chrome brillant et les bondes en céramique offrent des solutions originales et fonctionnelles pour aménager n'importe quel environnement de salle de bain.

La oferta Bahia_13 se enriquece aún más con los armarios con cajones, de 2 profundidades y modulares, con las medidas de los lavabos y disponibles en 5 colores naturales. Los dos cajones del mueble tienen laterales en metal pintado, guías totalmente extraíbles y cierre suave para garantizar una mayor comodidad de uso. El fondo interno de los cajones revestido con un material efecto cuero, a juego con la estructura interna, lo que le da valor y practicidad al mueble. Además, una serie de estructuras metálicas con cómodos estantes de almacenaje, disponibles tanto en suelo como en pared, los toalleros, tanto frontales como laterales, los sifones con un refinado diseño, regulables en altura, disponibles en negro mate y cromo brillo y el desagües cerámicos, ofrecen soluciones originales y funcionales para amueblar cualquier baño.

Предложение Bahia_13 дополнено структурами для хранения с ящиками, с 2 глубинами и модульным размером с умывальником и доступными в 5 натуральных цветах.

Два ящика шкафа имеют боковые стороны из окрашенного металла с полностью выдвигаемыми направляющими и мягким закрытием для большего комфорта при использовании. Внутреннее дно ящиков покрыто материалом с эффектом кожи того же цвета, что и внутренняя структура, что придает шкафу дороговизну и практичность. Кроме того, серия металлических конструкций с удобными полками для хранения, доступными как напольные, так и на подвесные версии, штанги для полотенец, как передние, так и боковые, сифоны изысканного дизайна, регулируемые по высоте, доступные в матовом черном и глянцево хромировании и керамические накладки на слив предлагают оригинальные и функциональные решения для оформления любой ванной комнаты.



BAHIA_13 ACCESSORI COORDINATI PER UN'OFFERTA REALMENTE INTEGRATA

Coordinated accessories for a truly integrated offer
Koordinierte Zubehöre für ein effektives integriertes Angebot
Accessoires coordonnés pour une offre véritablement intégrée
Accesorios a juego para una oferta verdaderamente integrada
Дополнительные аксессуары для действительно комплексного предложения

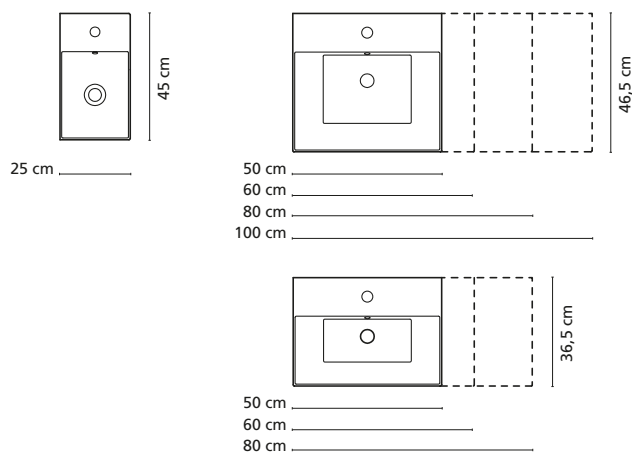

- BIANCO
WHITE
- ROVERE SHERWOOD CHIARO
LIGHT OAK
- ROVERE SHERWOOD CASTANO
CHESTNUT OAK
- ROVERE SHERWOOD SCURO
DARK OAK
- CEMENTO/TORTORA
CEMENT/DOVE GRAY







02

01: LAVABO 100x46,5 SENZA FORO RUBINETTERIA, SENZA FORO TROPPO PIENO CON PILETTA IN CERAMICA -
MOBILE 100 CEMENTO/TORTORA, SPECCHIO RETTANGOLARE 80x70

02: LAVABO 80x46,5 DESTRO CON FORO RUBINETTERIA, CON FORO TROPPO PIENO E PILETTA IN CERAMICA -
MOBILE 80 BIANCO, SPECCHIO RETTANGOLARE 80x70

01: wasbasin 100x46,5 without tap hole and overflow, ceramic drain - furniture 100 cement/dove gray, rectangular mirror 80x70

02: washbasin 80x46,5 right shelf one hole, with overflow and ceramic drain - furniture 80 white, rectangular mirror 80x70



03

03: LAVABO 60x46,5 CON FORO RUBINETTERIA, FORO TROPPO PIENO CON BORCHIETTA BIANCA E PILETTA IN CERAMICA -
MOBILE 60 ROVERE CHIARO, SPECCHIO RETTANGOLARE 60x70

04: LAVABO 80x46,5 BIANCO MATT CON FORO RUBINETTERIA, FORO TROPPO PIENO E PILETTA IN CERAMICA - SPECCHIO TONDO Ø60

05: LAVABO 50x46,5 SENZA FORO RUBINETTERIA, SENZA TROPPO PIENO CON PILETTA IN CERAMICA -
PORTASCIUGAMANI, SPECCHI TONDI Ø80

03: washbasin 60x46,5 one hole, overflow with white cover and ceramic drain - furniture 60 rovere chiaro, rectangular mirror 60x70

04: matt white washbasin 80x46,5 one hole, overflow and ceramic drain - round mirror Ø60

05: washbasin 50x46,5 without tap hole, without overflow, with ceramic drain - towel rack, round mirrors Ø80



04



05



06

06: LAVABO 80x36,5 SENZA FORO RUBINETTERIA, CON FORO TROPPO PIENO - STRUTTURA A TERRA NERO MATT,
VASCA RETTANGOLARE BT_02 170x74 BIANCO MATT, SPECCHIO RETTANGOLARE 100x70

06: washbasin 80x36,5 without tap hole, with overflow – black matt metal structure, matt white rectangular bathtub BT_02 170x74, rectangular mirror 100x70





07

07: LAVABO 80x36,5 CON FORO RUBINETTERIA, SENZA FORO TROPPO PIENO - STRUTTURA SOSPESA CROMO,
SPECCHIO RETTANGOLARE 80x70

07: washbasin 80x36,5 one hole, without overflow - wall hung chromed metal structure, rectangular mirror 80x70



08

08: LAVABO 50x36,5 CON FORO RUBINETTERIA , FORO TROPPO PIENO CON BORCHIETTA INOX -
SPECCHIO RETTANGOLARE 40x70, PORTASCIUGAMANO LATERALE CROMO

08: washbasin 50x36,5 one hole, overflow and inox drain – rectangular mirror 40x70, side chromed towel rack



09



10

09: LAVABO 60x36,5 BIANCO MATT 3 FORI RUBINETTERIA , CON FORO TROPPO PIENO - MOBILE 60 ROVERE CASTANO, SPECCHIO TONDO CON CORDA IN ECOPELLE E CORNICE NERA Ø60

10: LAVAMANI 45x25 CON FORO RUBINETTERIA - MOBILE ROVERE SCURO, SPECCHIO RETTANGOLARE 40x70

09: matt white washbasin 60x36,5 three tap holes, overflow - furniture 60 rovere castano, round mirror with faux leather cord and black frame Ø60
 10: wand wash 45x25 one hole - furniture rovere scuro, rectangular mirror 40x70



11

11: LAVABI SOTTOPIANO 50x38 CON PILETTA CERAMICA, SPECCHI TONDI Ø60

11: under counter washbasins 50x38 with ceramic drain, round mirror Ø60



PETRA_H3 Ardesia

DESIGN, AFFIDABILITÀ E VERSATILITÀ CHE RIDISEGNANO GLI SPAZI DOCCIA
DESIGN, RELIABILITY AND VERSATILITY THAT REDESIGN SHOWER SPACES



BAHIA_13

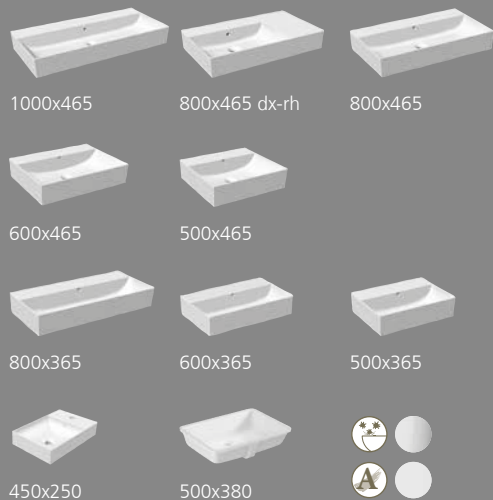

HAPPY HOUR SLIM



FUSION



BIANCA



PETRA H3_ARDESIA

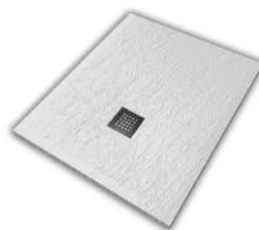
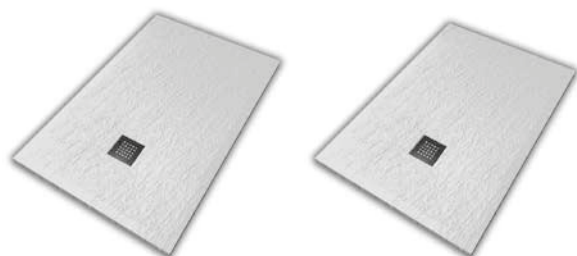
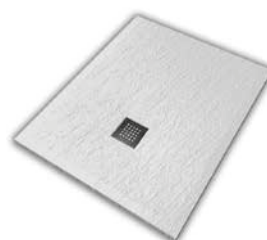
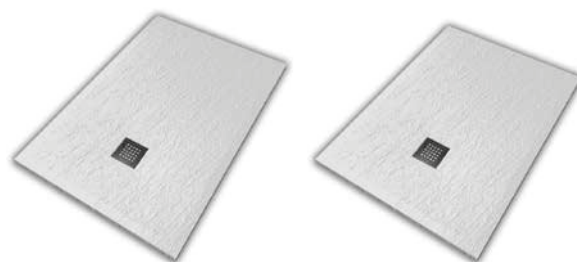

-
- 01 BIANCO**
WHITE
- 12 AVORIO**
IVORY
- 07 CEMENTO**
CEMENT
- 02 NERO**
BLACK



INIMITABILE DESIGN E TECNOLOGIA CERAMICA “MADE IN ITALY”

Inimitable Design and "Made in Italy" ceramic technology
 Unnachahmliches Design und Keramiktechnologie "Made in Italy"
 Design inimitable et technologie céramique «Made in Italy»
 Diseño inimitable y tecnología cerámica "Made in Italy"
 Неповторимый дизайн и технология "Made in Italy"

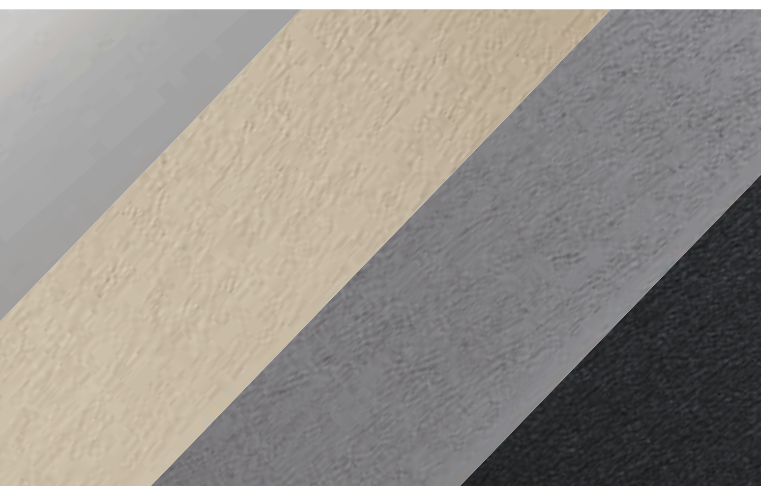

Petra_H3 Ardesia è la nuova linea di piatti doccia in ceramica realizzata da Hatria grazie ai recenti investimenti tecnologici che permettono di raggiungere altissimi livelli estetici e funzionali. Questa nuova linea di piatti doccia dall'unica superficie ceramica ispirata all'ardesia, permette di avere una finitura naturale, con dettagli in altissima definizione, e incredibilmente materica, conferendo alla "zona doccia" un aspetto unico, elegante e molto ricercato. La collezione Petra_H3 Ardesia è realizzata integralmente "Made in Italy" ed è disponibile in 6 dimensioni (da 100x70, fino al 140x80cm) e 4 colori, studiati con tonalità che permettono di inserirli in modo armonioso in tutti gli ambienti bagno, sia in appoggio che filo pavimento, grazie allo spessore di soli 3 cm. Gli accessori coordinati di altissima qualità, come la speciale piletta in acciaio inox o colorata in tinta con il piatto doccia, completano l'offerta, permettendo di raggiungere il massimo risultato estetico.

Petra_H3 Ardesia is the new line of ceramic shower trays created by Hatria thanks to recent technological investments that allow it to reach very high aesthetic and functional levels. This new line of shower trays with an original ceramic surface inspired by slate, allows for a natural finish, with extremely high definition details and incredibly material, giving the "shower area" a unique, elegant and highly refined look. The Petra_H3 Ardesia collection is entirely "Made in Italy" and it is available in 6 sizes (from 100x70, up to 140x80cm) and 4 colors, designed with colours that allow them to be inserted harmoniously in all bathrooms, both in at the floor level and above the floor, thanks to the thickness of only 3 cm. The coordinated accessories of the highest quality, such as the special stainless steel drain or colored matching the shower tray, complete the offer, allowing you to achieve the maximum aesthetic result.

Petra_H3 Ardesia ist die neue Linie von Keramik-Duschwannen, die Hatria dank der jüngsten technologischen Investitionen entwickelt hat, die es ermöglicht haben, ein sehr hohes ästhetisches und funktionales Niveau zu erreichen. Diese neue Kollektion von Duschwannen mit einer einzigen Keramikoberfläche, die von Schiefer inspiriert ist, ermöglicht ein natürliches Finish mit extrem hochauflösenden Details und unglaublichem Material und verleiht dem "Duschraum" ein einzigartiges, elegantes und begehrtes Aussehen. Die Petra_H3 Ardesia-Kollektion wird vollständig "Made in Italy" hergestellt und ist in 6 Größen (von 100 x 70 bis 140 x 80 cm) und 4 Farben erhältlich. Die Farben sind so gestaltet, dass sie sich harmonisch in alle Badezimmer einfügen werden, sowohl aufgesetzt als auch zur Bodenebene, dank der Dicke von nur 3 cm. Das abgestimmte Zubehör ist von höchster Qualität, wie der spezielle Edelstahlablauf oder farblich passend zur Duschwanne, runden das Angebot ab und ermöglicht Ihnen ein maximales ästhetisches Ergebnis.

Petra_H3 Ardesia est la nouvelle ligne de receveurs de douche en céramique créée par Hatria qui grâce aux récents investissements technologique, qui lui permettent d'atteindre des niveaux esthétiques et fonctionnels très élevés. Cette nouvelle ligne de receveurs de douche avec une seule surface en céramique unique inspirée de l'ardoise, permet une finition naturelle, avec des détails de haute définition, et une matière incroyable, donnant à la "zone de douche" un aspect unique, élégant et très raffiné. La collection Petra_H3 Ardesia est entièrement réalisée "Made in Italy" et est disponible en 6 tailles (de 100x70, jusqu'à 140x80cm) et 4 couleurs, conçues dans des tonalités qui leur permettent de s'intégrer harmonieusement dans toutes les salles de bains, à la fois posés et au ras du sol, grâce à une épaisseur de seulement 3 cm. Les accessoires coordonnés de la plus haute qualité, tels que la bonde spéciale en acier inoxydable ou colorée pour correspondre au receveur de douche, complètent l'offre, vous permettant d'obtenir le résultat esthétique maximal.

Petra_H3 Ardesia es la nueva línea de platos de ducha cerámicos creada por Hatria gracias a las recientes inversiones tecnológicas que le permiten alcanzar niveles estéticos y funcionales muy elevados. Esta nueva línea de platos de ducha con una original superficie cerámica inspirada en la pizarra, permite un acabado natural, con detalles de altísima definición e increíblemente material, dando a la "zona de ducha" un aspecto único, elegante y muy refinado. La colección Petra_H3 Ardesia es íntegramente "Made in Italy" y está disponible en 6 tamaños (desde 100x70, hasta 140x80cm) y 4 colores, diseñados con colores que permiten insertarlos armoniosamente en todos los baños, tanto a nivel del suelo y por encima del suelo, gracias al grosor de tan solo 3 cm. Los complementos coordinados de altísima calidad, como el desagüe especial de acero inoxidable o el plato de ducha de color a juego, completan la oferta, permitiéndote conseguir el máximo resultado estético.

Petra_H3 Ardesia - это новая линия керамических душевых поддонов, созданная фабрикой Hatria благодаря недавним технологическим инвестициям, которые позволяют достичь очень высокого эстетического и функционального уровня. Эта новая линия душевых поддонов с единой керамической поверхностью, вдохновленной сланцем, обеспечивает естественную отделку с деталями чрезвычайно высокой четкости и невероятным материалом, что придает «душевой зоне» уникальный, элегантный и очень изысканный вид. Коллекция Petra_H3 Ardesia полностью «Made in Italy» и доступна в 6 размерах (от 100x70 до 140x80 см) и 4 цветах, с оттенками, которые позволяют гармонично вписать их во все ванные комнаты, как в на пол, так и вровень с полом благодаря толщине всего 3 см. Дополнительные аксессуары высочайшего качества, такие как специальный слив из нержавеющей стали или окрашенный в тон душевого поддона, дополняют предложение, позволяя достичь максимального эстетического результата.



ANTIMACCHIA
Stain resistant
Fleckenbeständig
Résistant aux taches
Resistente a las manchas
Устойчивость к пятнам
UNI 4543



SEMPLICE DA PULIRE
Simple to clean
Einfach zu reinigen
Simple à nettoyer
Simple de limpiar
Легко чистить



SUPERFICIE ANTIBATTERICA
Antibacterial surface
Antibakterielle Oberfläche
Surface antibactérienne
Superficie antibacteriana
Антибактериальная поверхность



RESISTENTE AGLI ACIDI, ALCALI
Resistant to acids, alkalis
Beständig gegen Säuren, Laugen
Résistant aux acides, aux alcalis
Resistente a ácidos, álcalis
Устойчив к кислотам, щелочам



ANTISCIVOLO
Non-slip
Rutschfest
Antidérapant
Antideslizante
Нескользящий
RA_DIN 51097



PILETTA GEBERIT
Geberit drain
Geberit-Ablauf
Bonde Geberit
Drenaje Geberit
Слив Geberit

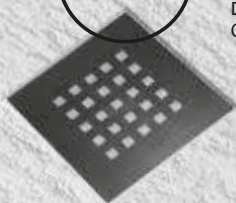

SICUREZZA E AFFIDABILITÀ AL 100%

100% Safety and Reliability
100% Sicherheit und Zuverlässigkeit
100% sécurité et fiabilité
100% seguridad y confiabilidad
100% безопасность и надежность

I piatti doccia Petra_H3 Ardesia sono realizzati con un'esclusiva tecnologia capace di offrire lo stesso risultato estetico della pietra ardesia utilizzando la ceramica, il materiale più duraturo e affidabile nel tempo per eccellenza. L'innovativo processo tecnologico ad alta pressione consente di ottenere un prodotto di elevatissima qualità utilizzando solo materiali naturali, in contrapposizione netta con i composti sintetici e le resine che non riescono, per propria natura, a garantire performance consistenti nel tempo. Lo smalto ceramico antibatterico Hatria rende particolarmente igienico il piatto doccia, facile da pulire (anti-macchia, testato UNI 4543, blu dimetilene, inchiostro, tintura di iodio e permanganato di potassio) e conferisce caratteristiche nettamente superiori in termini di durata e resistenza rispetto alle superfici in resina (che contrariamente sono porose, e potrebbero tendere ad assorbire agenti esterni). I laboratori Hatria hanno infine arricchito lo smalto di Petra_H3 Ardesia con proprietà anti-scivolo (aderenti alle normative Europee DIN 51097) per assicurare la massima sicurezza durante l'utilizzo.

Petra_H3 Ardesia shower trays are made with an exclusive technology capable of offering the same aesthetic result as slate stone using ceramic, the most durable and reliable material par excellence over time. The innovative high-pressure technological process makes it possible to obtain a high quality product using only natural materials, in clear contrast with synthetic composites and resins that cannot, by their very nature, guarantee consistent performance over time. The Hatria antibacterial ceramic glaze makes the shower tray particularly hygienic, easy to clean (anti-stain, UNI 4543 tested, dimethylene blue, ink, iodine dye and potassium permanganate) and confers clearly superior characteristics in terms of durability and resistance compared to resin surfaces (which, on the contrary, are porous, and could tend to absorb external agents). Finally, the Hatria laboratories have enriched the Petra_H3 Ardesia glaze with anti-slip properties (in compliance with the European DIN 51097 standards) to ensure maximum safety during use.

Petra_H3 Ardesia Duschwannen werden mit einer exklusiven Technologie hergestellt, die das gleiche ästhetische Ergebnis wie Schieferstein mit Keramik erzielen kann, dem haltbarsten und zuverlässigsten Material schlechthin im Laufe der Zeit. Das innovative technologische Hochdruckverfahren ermöglicht es, ein Produkt von höchster Qualität nur mit natürlichen Materialien zu erhalten, im Gegensatz zu synthetischen Verbundwerkstoffen und Harzen, die naturgemäß nicht in der Lage sind, über einen längeren Zeitraum eine gleichbleibende Qualität zu gewährleisten. Die antibakterielle Keramikglasur von Hatria macht die Duschwanne besonders hygienisch, leicht zu reinigen (Anti-Fleck UNI 4543 getestet, Dimethylenblau, Tinte, Jodfarbstoff und Kaliumpergament)

und bietet deutlich überlegene Eigenschaften hinsichtlich Haltbarkeit und Beständigkeit im Vergleich zu Harzoberflächen (die im Gegenteil porös sein und könnten dazu neigen externe Mittel zu absorbieren). Schließlich haben die Hatria-Labors die Petra_H3 Ardesia-Glasur mit rutschfesten Eigenschaften (gemäß den europäischen Normen DIN 51097) angereichert, um maximale Sicherheit während des Gebrauchs zu gewährleisten.

Les receveurs de douche Petra_H3 Ardesia sont fabriqués avec une technologie exclusive capable d'offrir le même résultat esthétique que la pierre d'ardoise en utilisant la céramique, le matériau par excellence le plus durable et le plus fiable dans le temps. Le procédé technologique innovant à haute pression permet d'obtenir un produit de très haute qualité en utilisant uniquement des matériaux naturels, en contraste frappant avec les composites synthétiques et les résines qui sont incapables, par leur nature même, d'assurer des performances constantes dans le temps. L'émail céramique antibactérien Hatria rend le receveur de douche particulièrement hygiénique, facile à nettoyer (anti-taches, testé UNI 4543, bleu de méthylène, encre, colorant iodé et permanganate de potassium) et confère des caractéristiques nettement supérieures en termes de durabilité et de résistance par rapport aux surfaces en résine (qui, au contraire, sont poreuses, et pourraient ont tendance à absorber les agents externes). Enfin, les laboratoires Hatria ont enrichi l'émail Petra_H3 Ardesia de propriétés antidérapantes (adhérant aux normes européennes DIN 51097) pour assurer une sécurité maximale lors de l'utilisation.

Los platos de ducha Petra_H3 Ardesia están fabricados con una tecnología exclusiva capaz de ofrecer el mismo resultado estético que la piedra pizarra utilizando cerámica, el material más duradero y fiable por excelencia en el tiempo. El innovador proceso tecnológico de alta presión permite obtener un producto de alta calidad utilizando únicamente materiales naturales, en claro contraste con los componentes sintéticos y resinas que no pueden, por su propia naturaleza, garantizar un rendimiento constante en el tiempo. El esmalte cerámico antibacteriano Hatria hace que el plato de ducha sea especialmente higiénico, fácil de limpiar (anti manchas, probado UNI 4543, azul de dimetileno, tinta, colorante de yodo y permanganato de potasio) y le confiere unas características claramente superiores en cuanto a durabilidad y resistencia a las superficies de resina (que, por el contrario, son porosas, pudiendo tender a absorber agentes externos). Finalmente, los laboratorios de Hatria han enriquecido el esmalte Petra_H3 Ardesia con propiedades antideslizantes (en cumplimiento de las normas europeas DIN 51097) para garantizar la máxima seguridad durante el uso.

Душевые поддоны Petra_H3 Ardesia изготовлены по эксклюзивной технологии, способной обеспечить такой же эстетический результат, как и сланцевый камень, с использованием керамики, самого прочного и надежного материала даже с течением времени. Инновационный технологический процесс высокого давления позволяет получить продукт высочайшего качества, используя только натуральные материалы, в отличие от синтетических композитов и смол, которые по самой своей природе не могут обеспечить стабильные характеристики с течением времени. Антибактериальная керамическая эмаль Hatria делает душевой поддон особенно гигиеничным, легким в уходе (защищает от пятен испытано UNI 4543, диметиленовый синий, чернила, йодный краситель и калиевый пергмент) и обеспечивает явно лучшие характеристики с точки зрения долговечности и устойчивости по сравнению с полимерными поверхностями (которые, напротив, пористы и имеют свойство поглощать внешние агенты). Наконец, лаборатории Hatria обогатили эмаль Petra_H3 Ardesia противоскользящими свойствами (в соответствии с европейскими стандартами DIN 51097), чтобы обеспечить максимальную безопасность во время использования.

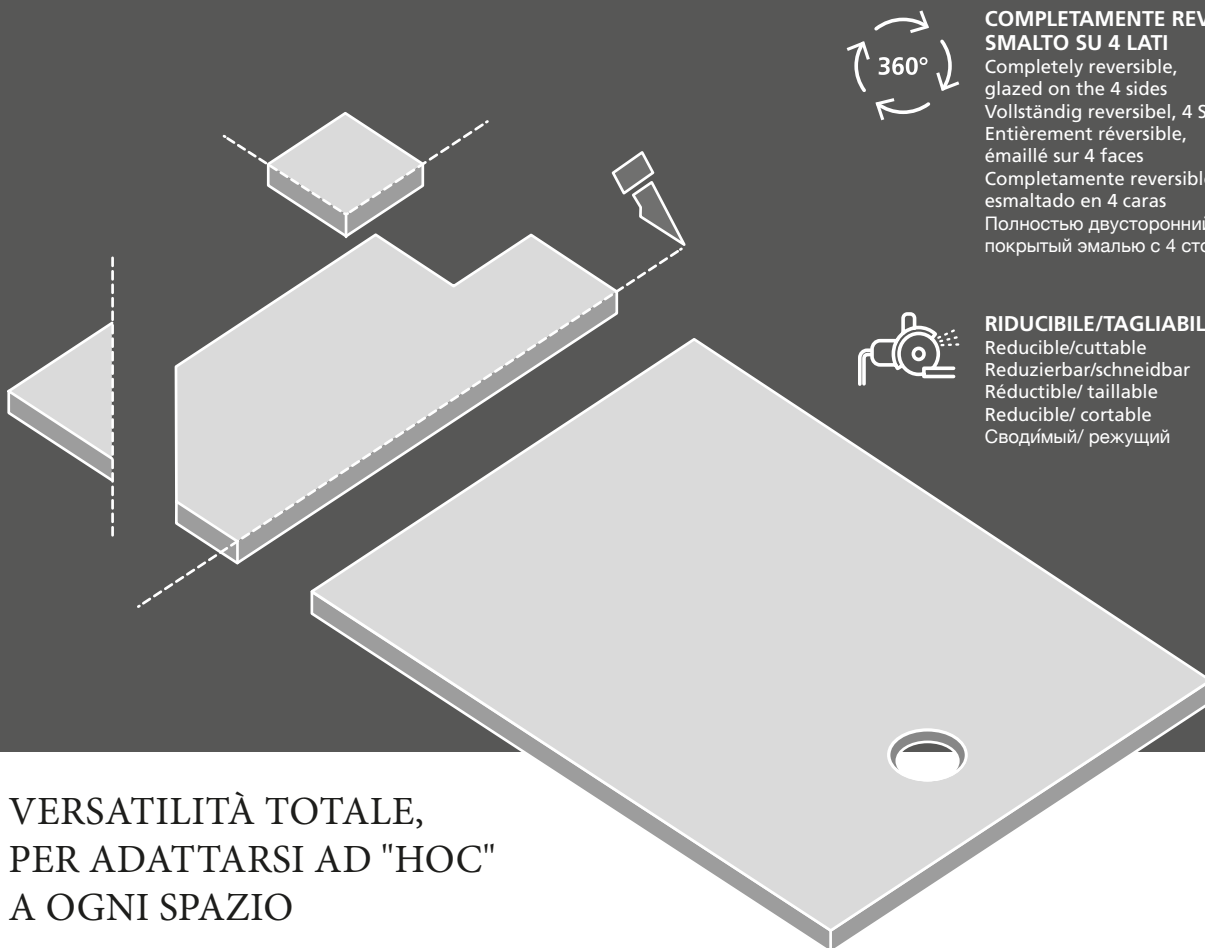

**COMPLETAMENTE REVERSIBILE,
SMALTO SU 4 LATI**

Completely reversible,
glazed on the 4 sides
Vollständig reversibel, 4 Seiten glasiert
Entièrement réversible,
émaillé sur 4 faces
Completamente reversible,
esmaltado en 4 caras
Полностью двусторонний,
покрытый эмалью с 4 сторон



RIDUCIBILE/TAGLIABILE

Reducible/cuttable
Reduzierbar/schneidbar
Réductible/ taillable
Reducible/ cortable
Сводимый/ режущий

**VERSATILITÀ TOTALE,
PER ADATTARSI AD "HOC"
A OGNI SPAZIO**

Total versatility, to suit to any space
Absolute Vielseitigkeit, um sich ad hoc an jeden Raum anzupassen
Polyvalence totale, pour s'adapter sur mesure à n'importe quel espace
Total versatilidad, para adaptarse a cualquier espacio
Полная универсальность, позволяющая адаптировать его к любому пространству

Nasce una nuova generazione di piatti doccia in ceramica che offre un'estrema flessibilità, grazie ai bordi smaltati sui 4 lati che garantiscono l'adattabilità in ogni tipologia di area doccia. Maggiormente, e grazie all'impasto sviluppato nei laboratori di Hatria, il piatto doccia Petra_H3 Ardesia è riducibile, quindi può essere ordinato tagliato su misura, per adattarsi con facilità a qualsiasi progetto bagno. Un valore aggiunto che traduce lo stile sartoriale tipico del Made in Italy nel linguaggio della ceramica, dando vita a una linea di piatti doccia versatile, di facile installazione e che diventi protagonista dell'ambiente bagno grazie ad un design che sposa le ultime tendenze dell'interior design.

A new generation of ceramic shower trays is born that offers extreme flexibility, thanks to the glaze edges on the 4 sides that provide adaptability in any type of shower area. More, thanks to the ceramic body developed in the Hatria laboratories, the Petra_H3 Ardesia shower tray is reducible, so it can be ordered with customized cut, to easily adapt to any bathroom project. An added value that translates the tailored style typical of Made in Italy into the language of ceramics, giving life to a line of versatile, easy-to-install shower trays and becoming the protagonist of the bathroom thanks to a design that marries the latest interior trends design.

Es entsteht eine neue Generation von Duschwannen aus Keramik, die dank der emaillierten Kanten an den 4 Seiten, die Anpassungsfähigkeit in jeder Art von Duschbereich gewährleisten, extreme Flexibilität bietet. Noch wichtiger ist, dass dank der in den Hatria-Labors entwickelten Mischung die Duschwanne Petra_H3 Ardesia kürzbar ist, sodass sie zugeschnitten werden kann, um sich problemlos an jedes Badezimmerprojekt anpassen zu können. Ein Mehrwert, der den für Made in Italy typischen Modestil in die Sprache der Keramik übersetzt und eine Reihe vielseitiger, einfach zu installierender Duschwannen zum Leben erweckt, die dank eines Designs, das die neuesten Trends vereint, zum Protagonisten des Badezimmers werden Innenarchitektur.

Une nouvelle génération de receveurs de douche en céramique est née, elle offre une flexibilité extrême, grâce aux bords émaillés sur les 4 côtés qui garantissent l'adaptabilité dans tout type de zone de douche. Plus important encore, grâce au mélange développé dans les laboratoires Hatria, le receveur de douche Petra_H3 Ardesia est réductible, il peut donc être commandé sur mesure, pour s'adapter facilement à tout projet de salle de bain. Une valeur ajoutée qui traduit le style vestimentaire typique du Made in Italy dans le langage de la céramique, donnant vie à une ligne de receveurs de douche polyvalents et faciles à installer qui deviennent le protagoniste de la salle de bain grâce à un design qui épouse les dernières tendances en matière de design d'intérieur.

Nace una nueva generación de platos de ducha cerámicos que ofrecen una flexibilidad extrema, gracias a los cantos vidriados en los 4 lados que aportan adaptabilidad en cualquier tipo de zona de ducha. Además, gracias al cuerpo cerámico desarrollado en los laboratorios Hatria, el plato de ducha Petra_H3 Ardesia es reducible, por lo que se puede pedir con corte personalizado, para adaptarse fácilmente a cualquier proyecto de baño. Un valor añadido que traduce el estilo sastrero típico del Made in Italy al lenguaje de la cerámica, dando vida a una línea de platos de ducha versátiles y fáciles de instalar y convirtiéndose en protagonista del baño gracias a un diseño que casa con el interior más actual, diseño de tendencias.

Рождение нового поколения керамических душевых поддонов, обладающих исключительной гибкостью благодаря эмалированным краям с 4 сторон, которые гарантируют адаптируемость к любому типу душевой зоны. Что еще более важно, благодаря смеси, разработанной в лабораториях Hatria, душевой поддон Petra_H3 Ardesia можно уменьшить, поэтому его можно обрезать по размеру, чтобы легко приспособить к любому проекту ванной комнаты.

Дополнительная ценность, которая переводит стиль одежды, типичный для Made in Italy, на язык керамики, давая жизнь линейке универсальных, простых в установке душевых поддонов, которые становятся главным героем ванной комнаты благодаря дизайну, сочетающему в себе последние тенденции в дизайн интерьера.



01

NERO / BLACK

01: PETRA H3_ARDESIA GRIGLIA INOX NERA 140x80 PERSONALIZZATO

01: PETRA H3_Ardesia 140x80 customized with stainless steel black square cover



PERSONALIZZATO Customized

Grazie alla sua facilità di taglio, è possibile adattare il piatto per misure speciali salvando colonne, muretti o angoli esistenti all'interno della casa.

Thanks to its ease of cutting, the shower tray can be adapted to special sizes to save existing columns, low wall or corners inside the house.

Das Material lässt sich leicht zuschneiden, die Duschplatte kann so auch an besondere Maße angepasst werden, auf diese Weise können bereits bestehende Säulen oder Ecken beibehalten werden.

Grâce à sa facilité de coupe, il est possible d'adapter le receveur à des dimensions spéciales en conservant les colonnes, muret ou les angles qui existent déjà à l'intérieur de la maison.

Gracias a la facilidad de corte, es posible adaptar el plato de ducha a medidas especiales, sin modificar columnas, murete o esquinas existentes de la casa.

Благодаря легкости обрезки поддон может быть адаптирован к особым размерам, что позволяет сохранять целыми колонны, низкая стена или углы, существующие в помещении.



BIANCO / WHITE

02: PETRA H3_ARDESIA GRIGLIA BIANCA / GRIGLIA INOX 120x70

02: PETRA H3_Ardesia 120x70 with stainless steel / white square cover



03

CEMENTO / CEMENT

03: PETRA H3_ARDESIA GRIGLIA CEMENTO 100x80

02: PETRA H3_Ardesia 100x80 with stainless steel white square cover



04

AVORIO / IVORY

04: PETRA H3_ARDESIA GRIGLIA INOX 140x80

02: *PETRA H3_Ardesia 140x80 with stainless steel square cover*

GAMMA GRIGLIE IN ACCIAIO: INOX E IN TINTA COL PIATTO DOCCIA

Color range of the steel grate: stainless steel or colored matching the shower tray

Farbpalette der Stahlgitter: Edelstahl oder in der gleiche Farbe der Duschwanne

Palette de couleurs de la grille en acier : acier inoxydable ou colorée comme le receveur de douche

Gama cromatica de la rejilla en acero: acero inoxidable o colorado a juego del plato de ducha

Цветовая гамма гриль из стали: нержавеющей сталь или окрашенный в тон душевого поддона

BIANCO / WHITE

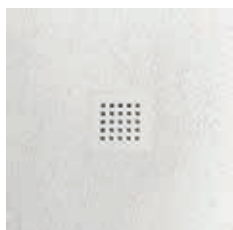

GRIGLIA BIANCO

white grate



GRIGLIA INOX

stainless steel grate

AVORIO / IVORY

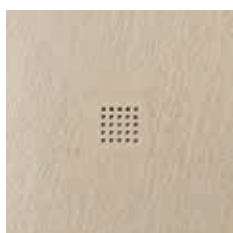

GRIGLIA AVORIO

ivory grate



GRIGLIA INOX

stainless steel grate

CEMENTO / CEMENT

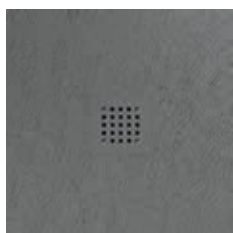

GRIGLIA CEMENTO

cement grate

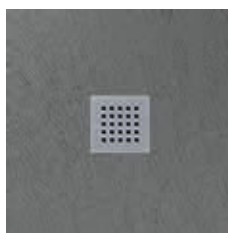

GRIGLIA INOX

stainless steel grate

NERO / BLACK

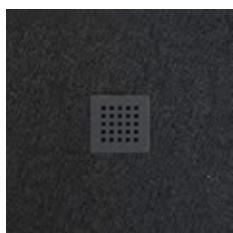

GRIGLIA NERO

black grate

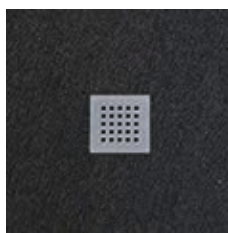

GRIGLIA INOX

stainless steel grate



BIANCA

ELEGANTE E CONTEMPORANEA
ELEGANT AND CONTEMPORARY



BAHIA_13



1000x465

800x465 dx-rh

800x465



600x465



500x465



800x365



600x365



500x365



450x250



500x380

HAPPY HOUR SLIM



250x250



400x400



440x440



500x380



550x380

HAPPY HOUR



475x475



470x470



480x480



500x380



550x405



440x440

BIANCA 360x520

PURE RIM

TRASLATO

OPEN BIDET



BIANCA 355x655x370



01 BIANCO
WHITE



25 BIANCO MATT
WHITE MATT



01

BIANCO MATT / WHITE MATT**01: VASO SCARICO TRASLATO PURE RIM + BIDET FILO MURO***01: PURE RIM shifted outlet back to wall wc + bidet*



02

02: VASO MONOBLOCCO CON CASSETTA

02: coupled wc with cistern



BIANCO MATT / WHITE MATT

03: VASO SCARICO TRASLATO PURE RIM + BIDET FILO MURO

03: PURE RIM shifted outlet back to wall wc + bidet



VASCHE FREESTANDING E SPECCHI



VASCHE FREESTANDING Freestanding Bathtubs

Le vasche centrostanza Hatria, dal design moderno ed elegante, sono studiate per conferire alla stanza da bagno una dimensione Wellness, regalando intimità e una sensazione di armonia e relax all'ambiente in cui sono collocate. Le vasche centrostanza, disponibili sia in bianco lucido che matt, sono la soluzione perfetta per chi desidera arredare la stanza da bagno in un modo ricercato e che doni la percezione quotidiana di vivere in uno spazio unico, ispirato al lusso e al prestigio.

The freestanding bathtubs Hatria, with a modern and elegant design, are studied to give the bathroom a Wellness dimension, giving intimacy and a feeling of harmony and relaxation to the environment in which they are located. The freestanding bathtubs, available in both glossy white and matt, are the perfect solution for those who want to furnish the bathroom in a refined way and which gives the daily perception of living in a unique space, inspired by luxury and prestige.

SPECCHIERE Mirrors

Le Specchiere Hatria arricchiscono con un tocco di design e personalità l'offerta per arredare la stanza da bagno, grazie alla varietà di forme disponibili, dal telaio in metallo nero e corda in ecopelle oppure con profilo di soli 4 millimetri filo lucido e retroilluminazione led perimetrale.

The mirrors Hatria enrich with a touch of design and personality the offer for furnishing the bathroom, thanks to the variety of shapes available, from the black metal frame and eco-leather cord or with a profile of only 4 mm with polished edge and perimeter LED backlighting.



01: VASCA FREESTANDING RETTANGOLARE BT_02 BIANCO LUCIDO
02: VASCA FREESTANDING RETTANGOLARE BT_02 BIANCO MATT

*01: white glossy rectangular bathtub BT_02
02: white matt rectangular bathtub BT_02*



03: VASCA FREESTANDING OVALE BT_01 BIANCO LUCIDO
04: VASCA FREESTANDING OVALE BT_01 BIANCO MATT

*03: white glossy oval bathtub BT_01
04: white matt oval bathtub BT_01*



05

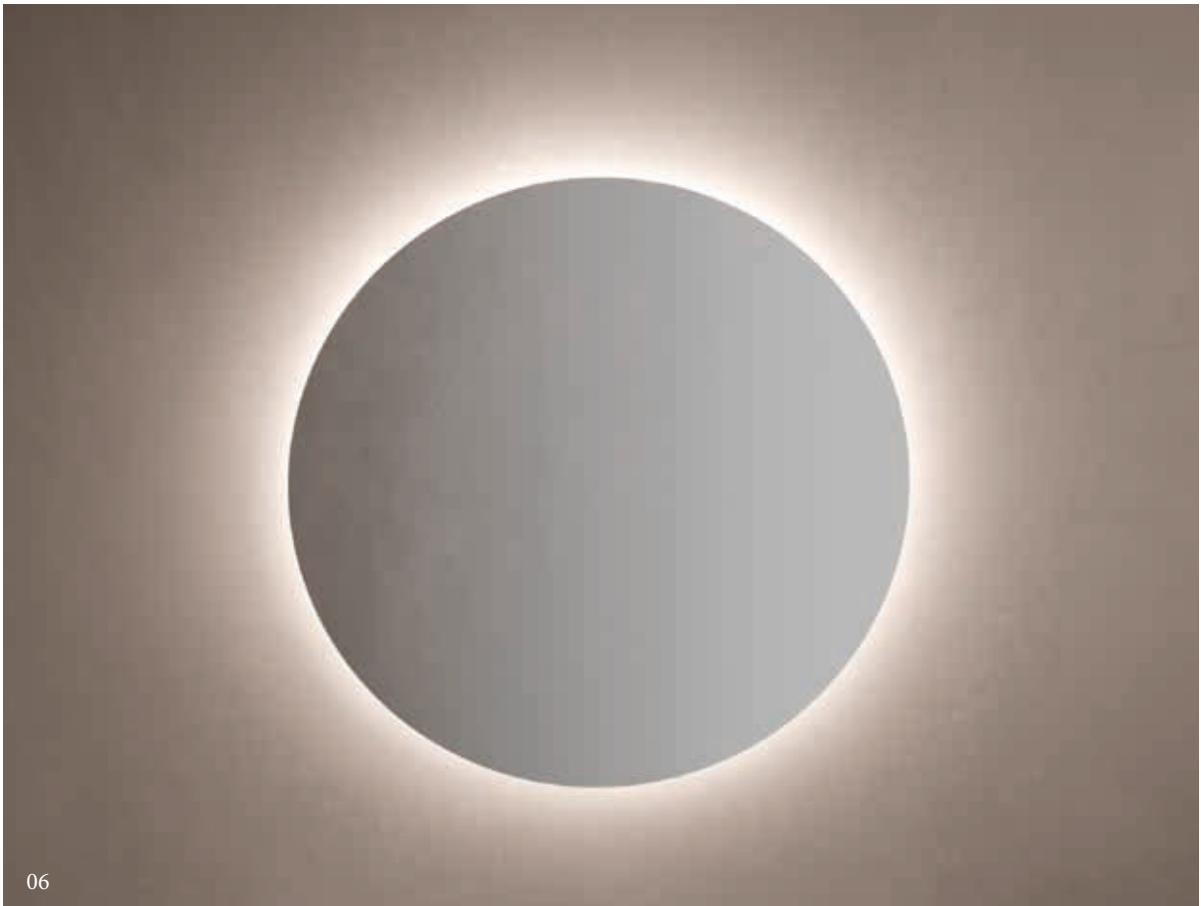

06



05: SPECCHIO TONDO CON CORDA IN ECOPELLE E CORNICE NERA Ø60

06: SPECCHIO TONDO RETROILLUMINATO Ø60

07: SPECCHIO RETTANGOLARE RETROILLUMINATO 40x70

05: round mirror with faux leather cord and black frame Ø60

06: backlit round mirror Ø60

07: backlit rectangular mirror 40x70



SPECCHIO TONDO CON CORDA IN ECOPELLE E CORNICE NERA Ø60
round mirror with faux leather cord and black frame Ø60

SPECCHIO TONDO CON CORDA IN ECOPELLE E CORNICE NERA Ø80
round mirror with faux leather cord and black frame Ø80



SPECCHIO TONDO RETROILLUMINATO Ø60
backlit round mirror Ø60

SPECCHIO TONDO RETROILLUMINATO Ø80
backlit round mirror Ø80



SPECCHIO RETTANGOLARE RETROILLUMINATO 40x70
backlit rectangular mirror 40x70

SPECCHIO RETTANGOLARE RETROILLUMINATO 60x70
backlit rectangular mirror 60x70

SPECCHIO RETTANGOLARE RETROILLUMINATO 80x70
backlit rectangular mirror 80x70

SPECCHIO RETTANGOLARE RETROILLUMINATO 100x70
backlit rectangular mirror 100x70

SCHEDE TECNICHE

TECHNICAL SHEETS

BAHIA_13

lavabo 100x46,5
washbasin 100x46,5

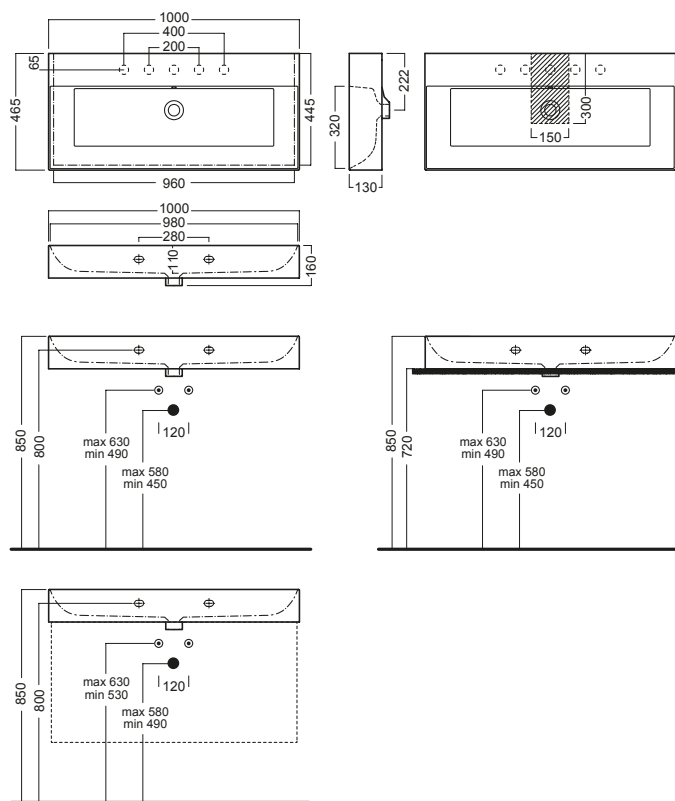

lavabo 80x46,5 destro
washbasin 80x46,5 right

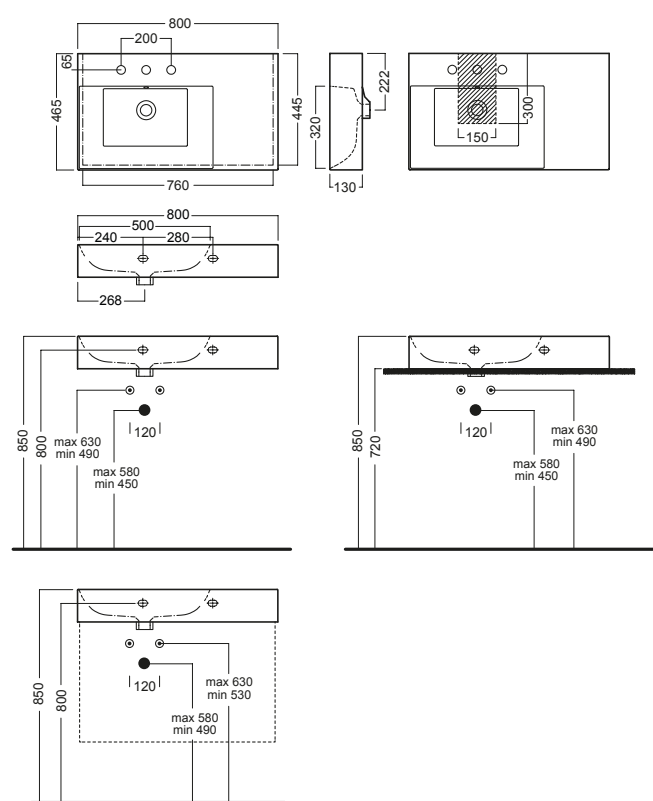

lavabo 80x46,5
washbasin 80x46,5

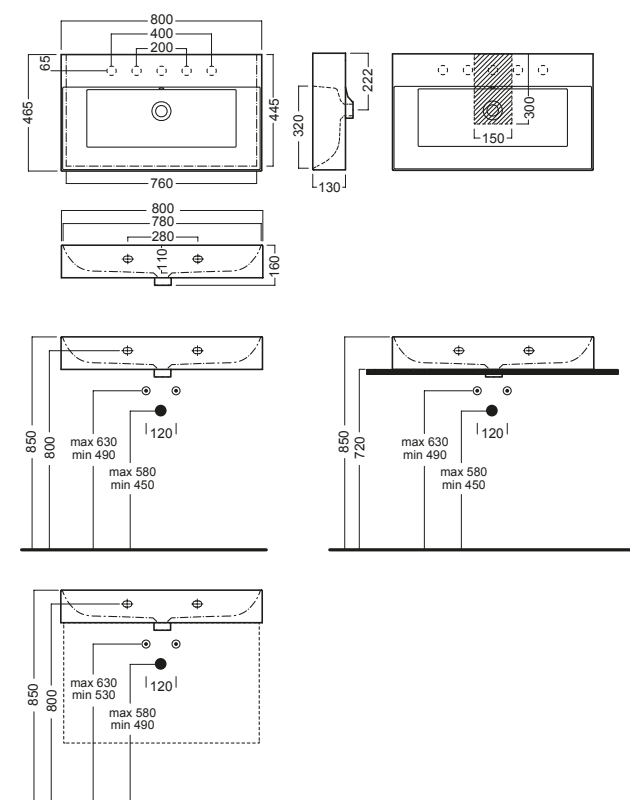

lavabo 80x36,5
washbasin 80x36,5

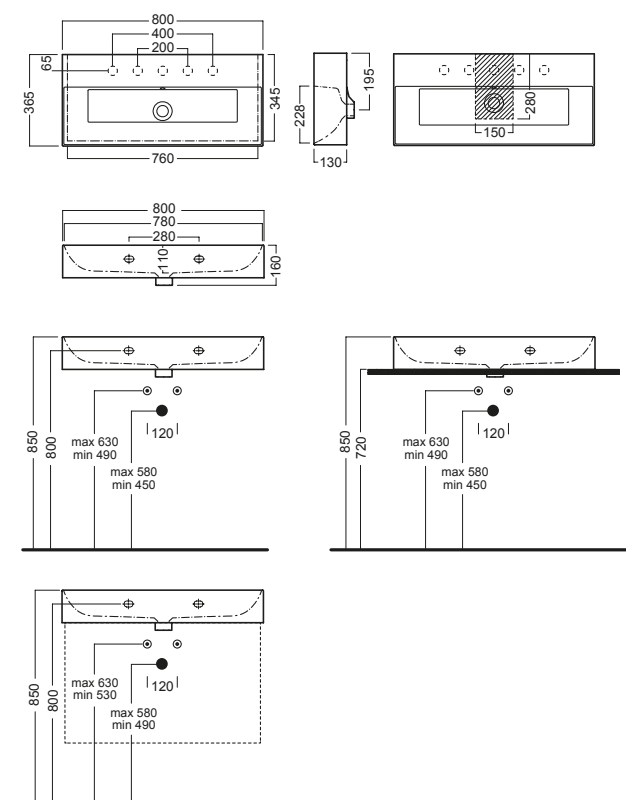

BAHIA_13

lavabo 60x46,5
washbasin 60x46,5

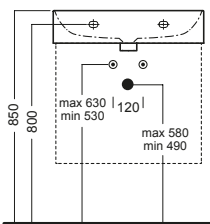
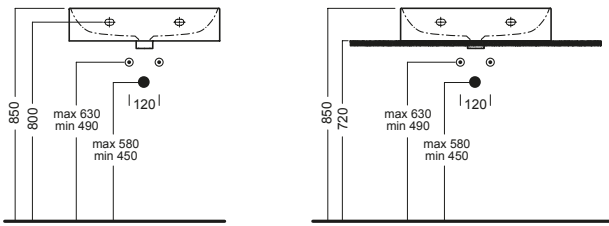
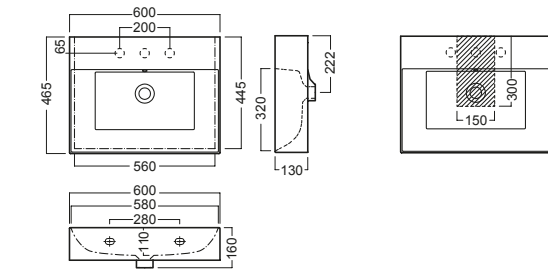

lavabo 60x36,5
washbasin 60x36,5

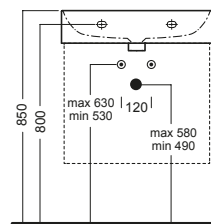
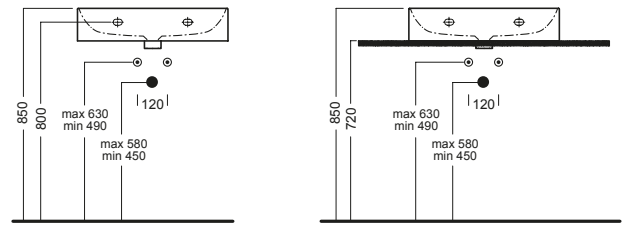
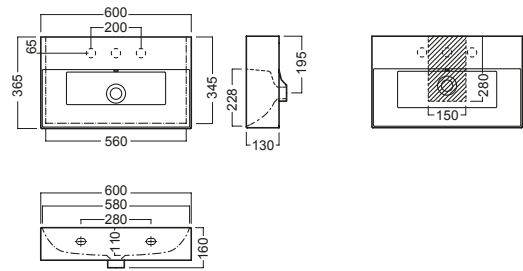

lavabo 50x46,5
washbasin 50x46,5

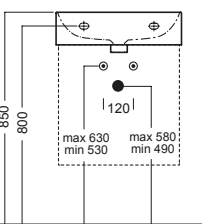
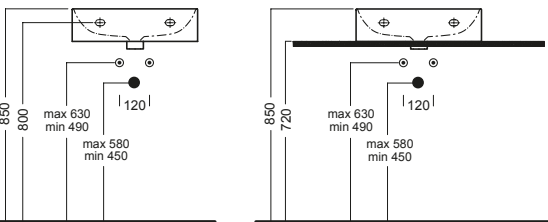
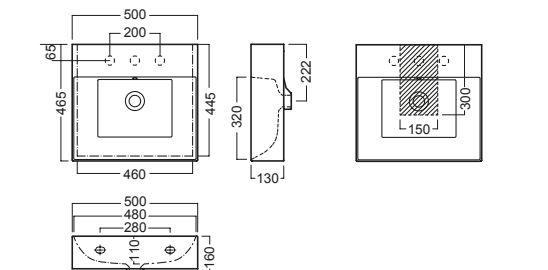

lavabo 50x36,5
washbasin 50x36,5

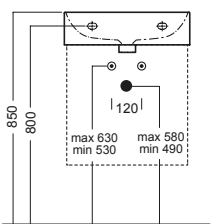
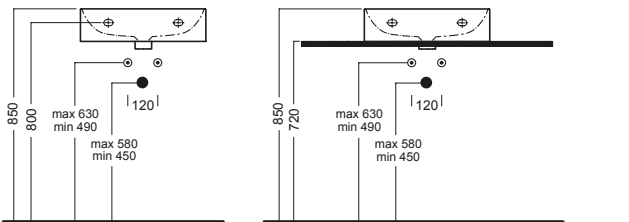
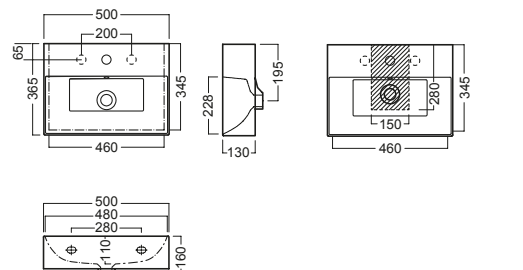

BAHIA_13

lavabo 50x38
washbasin 50x38

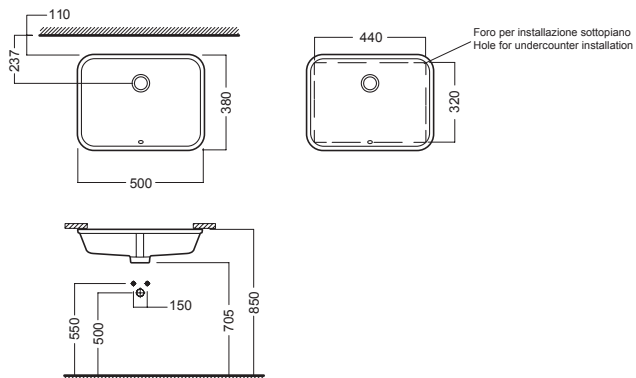

lavamani 45x25
handrinse basins 45x25

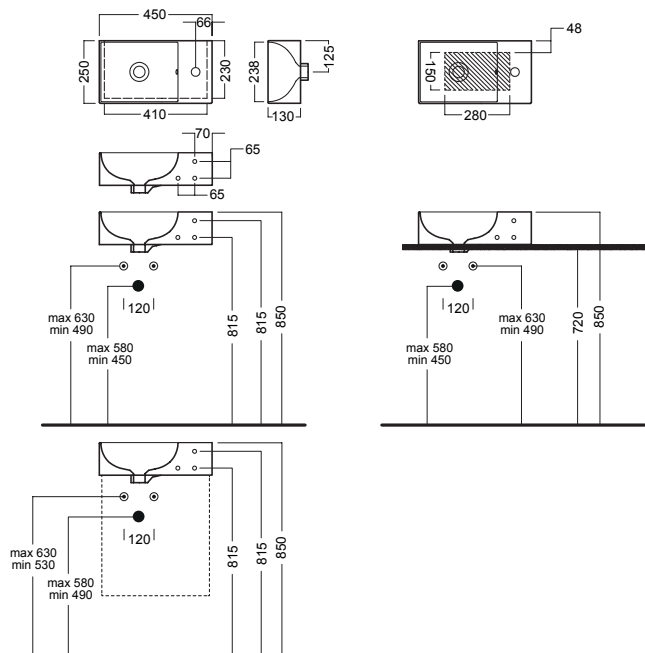

BAHIA_13

MOBILI - Furnitures

1 BIANCO
WHITE

2 CEMENTO/TORTORA
CEMENT/DOVE GRAY

3 ROVERE SHERWOOD CHIARO
LIGHT OAK

4 ROVERE SHERWOOD CASTANO
CHESTNUT OAK

5 ROVERE SHERWOOD SCURO
DARK OAK

BIANCA

vaso filo muro PURE RIM_SCARICO TRASLATO
PURE RIM back to wall wc_SHIFT DRAIN SYSTEM

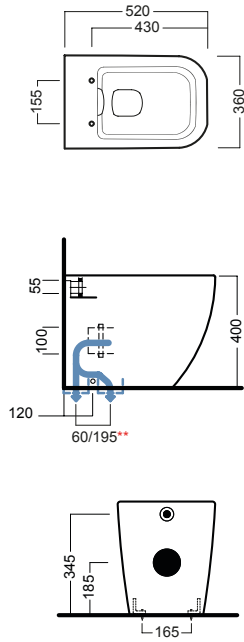

** 215mm Con Raccordo eccentrico per scarico Wc Y1PJ
215mm With eccentric pipe for wc outlet Y1PJ



*** Raccordo eccentrico per scarico Wc Y1PJ
Y1PJ Da installare a filo pavimento
Eccentric pipe for Wc outlet Y1PJ
Y1PJ To be installed floor level

bidet filo muro
back to wall bidet

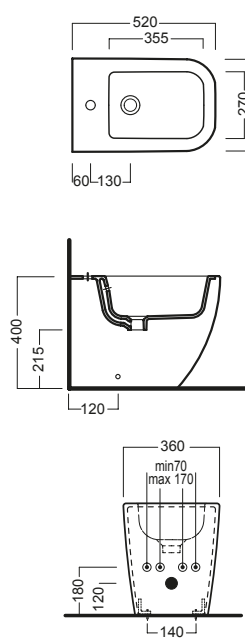

vaso monoblocco con cassetta
coupled wc with cistern

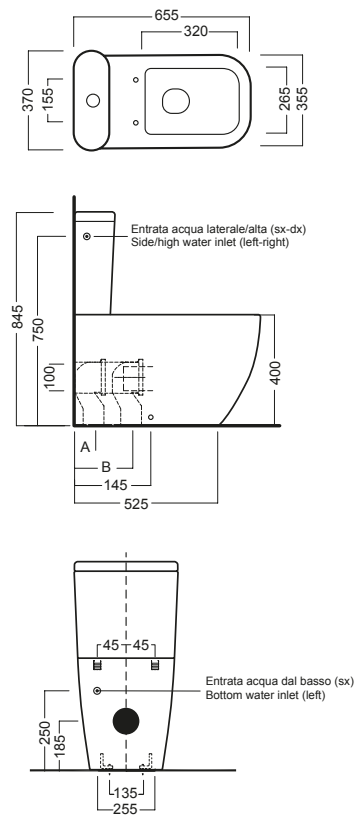

VASCHE FREESTANDING

vasca 170x78 BT_01
bathtub 170x78 BT_01

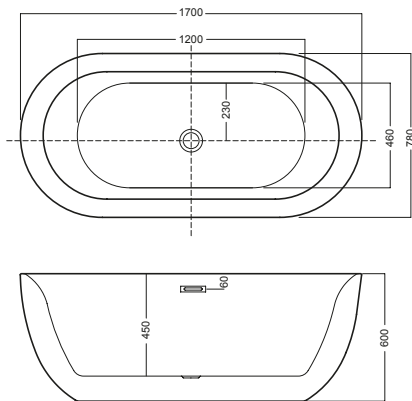

vasca 170x74 BT_02
bathtub 170x74 BT_02

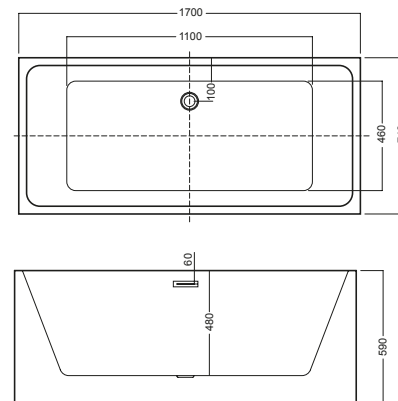

CONCEPT&GRAPHIC DESIGN

Ikos

© Copyright Hatria Srl

Stampa Gennaio 2020

8000

ABU

Hatria si riserva il diritto di apportare, in qualsiasi momento e senza preavviso, modifiche tecniche e dimensionali ai propri prodotti.
Hatria reserves the right to change the models at any moment and without notice.





hatria

Hatria S.r.l a socio unico
Via Isidoro e Lepido Facii Zona industriale S. Atto - 64020 Teramo - Italia
tel. +39 0861 2011 - fax +39 0861 201235
venditeitalia@hatria.com - exportdpt@hatria.com - marketing@hatria.com

www.hatria.com